

Name _____

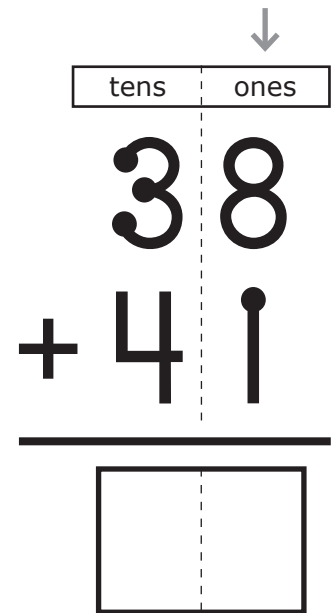

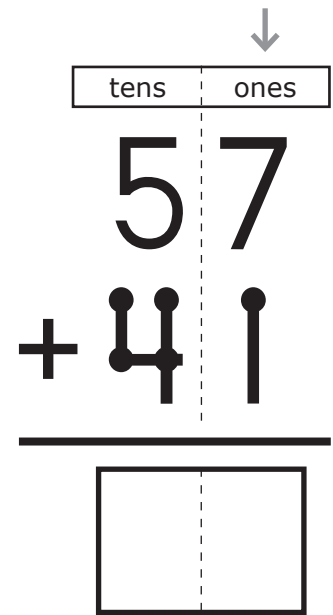

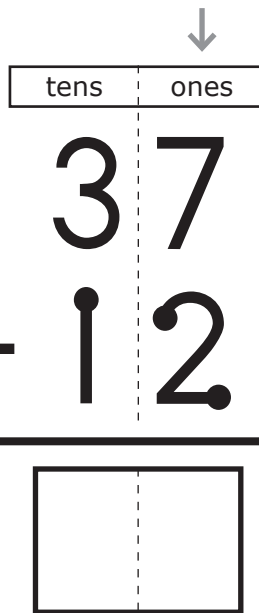

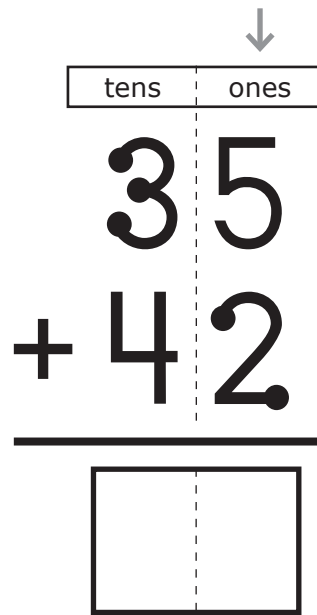
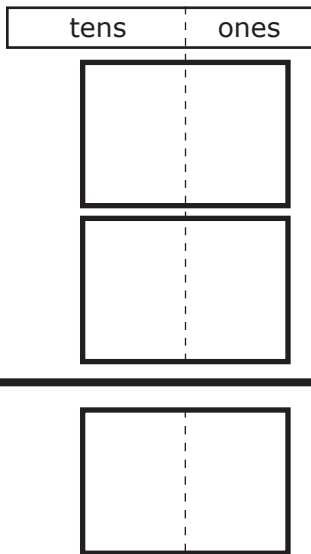
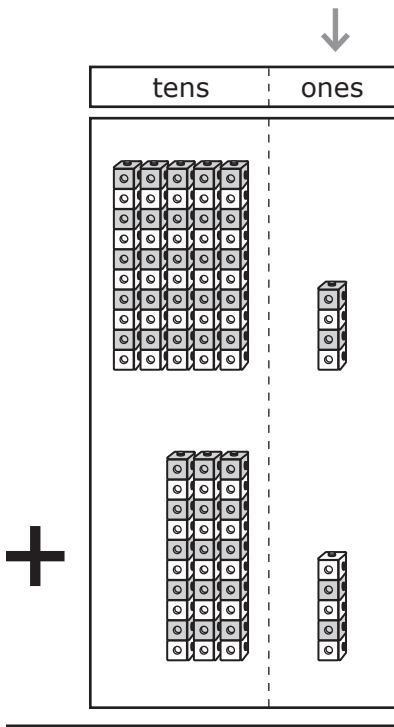



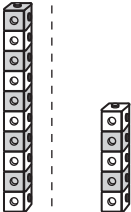

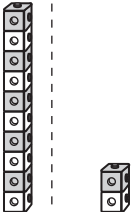

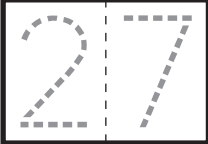
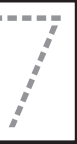

Laura has 21  (fish). Mike has 24 fish.

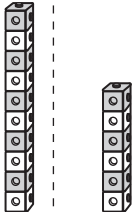

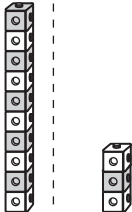



How many fish do Laura and Mike have **altogether**?

$$\begin{array}{|c|c|} \hline & \\ \hline \end{array} + \begin{array}{|c|c|} \hline & \\ \hline \end{array} = \begin{array}{|c|c|} \hline & \\ \hline \end{array} \text{ fish}$$

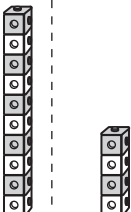

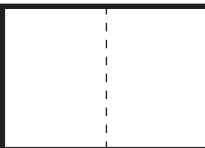
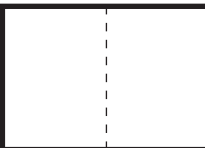
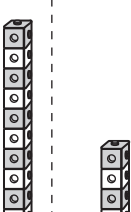

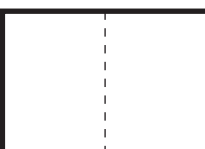
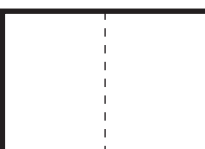

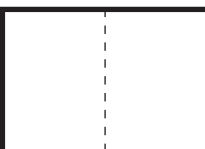
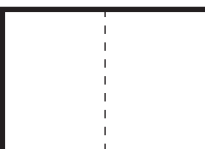
Name _____

	tens	ones	tens	ones
+			1	5
			1	2
				

	tens	ones	tens	ones
+			1	6
			1	3
				







	tens	ones	tens	ones
+				
				
				



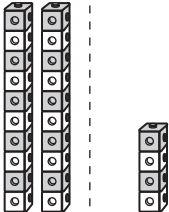

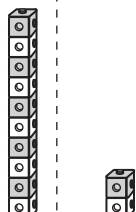
Jan has 12 balls. Ron gives her 16 more balls. How many balls does Jan have **in all**?



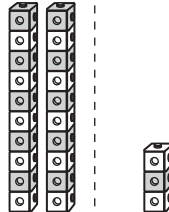

	tens	ones
+		
		
		

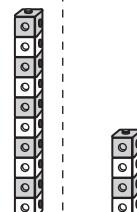
balls

Name _____

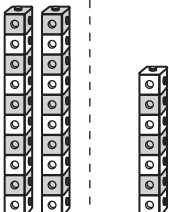
	tens	ones	tens	ones
+			2	4
			1	2
				

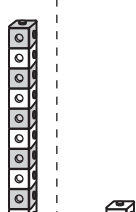



	tens	ones	tens	ones
+			2	3
			1	4



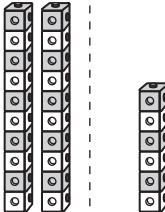

	tens	ones	tens	ones
+				
				

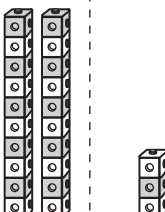

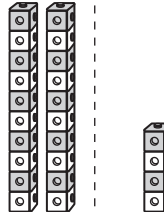

	tens	ones	tens	ones
	2	3	1	7
+	1	3	1	2
			>	

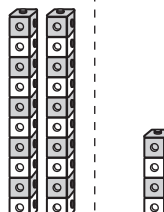
True False

Name _____

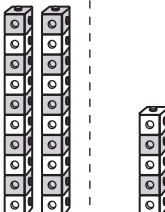
	tens	ones	tens	ones
+			2	6
			2	3
				

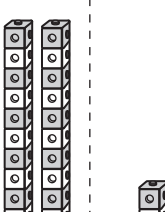
	tens	ones	tens	ones
+			2	4
			2	4

	tens	ones	tens	ones
+				
				

Loo has 23 nuts. Kwan gives Loo 24 more nuts. How many nuts does Loo have **altogether**?

	tens	ones
+		

nuts

Name _____

	tens	ones	tens	ones
+			2	4
			2	4

	tens	ones	tens	ones
+			1	2

	tens	ones	tens	ones
+				

24 beans are in a bag. Len puts 15 more beans in the bag. What is the **total** number of beans in the bag?

	tens	ones
+		

beans

Name _____

tens		ones		tens		ones	
				14			
				11			
+							

tens		ones		tens		ones	
				15			
				12			
+							

tens		ones		tens		ones	
+							

Sam hit the ball 15 times.
 Kip hit the ball 11 times.
 How many times did the ball get hit **altogether**?

tens		ones	
+			

times

Name _____

	tens	ones	tens	ones
+			2	5
			1	3

	tens	ones	tens	ones
+			2	7
			1	2





	tens	ones	tens	ones
+				





24 cats
are in the (barn).
13 cats
are in the (grass).
How many
cats are
there **in all**?



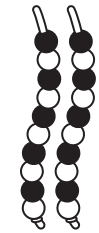

	tens	ones
+		

cats

Name _____

	tens	ones	tens	ones
+			2	3
			2	3
	4	6		







	tens	ones	tens	ones
+			2	5
			2	4





	tens	ones	tens	ones
+				
				





	tens	ones	tens	ones
+	1	6	1	4
	2	2	1	3
			=	

True False

Name _____

	tens	ones	tens	ones
+			2	4
			1	3
				

	tens	ones	tens	ones
+			2	5
			2	2

	tens	ones	tens	ones
+				
				

	tens	ones	tens	ones
+	1	3	2	4
	1	3	1	2

Name _____

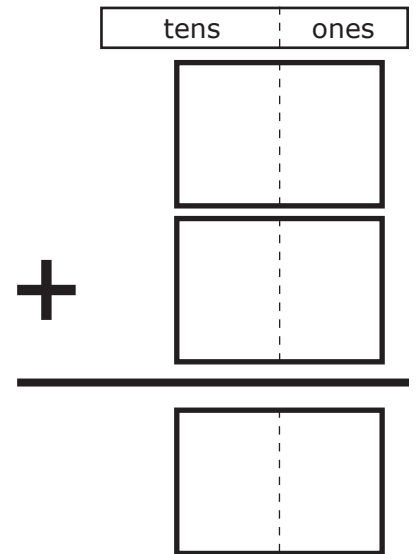
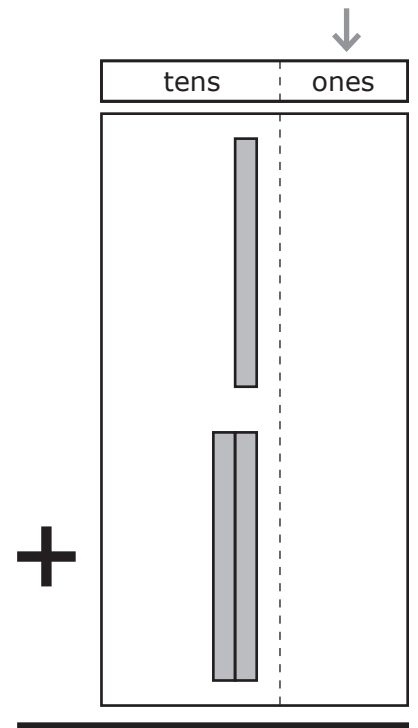
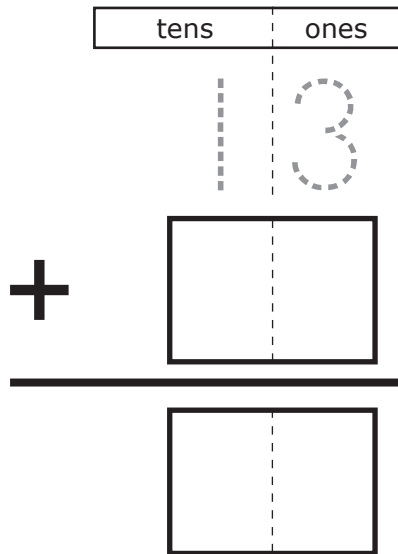
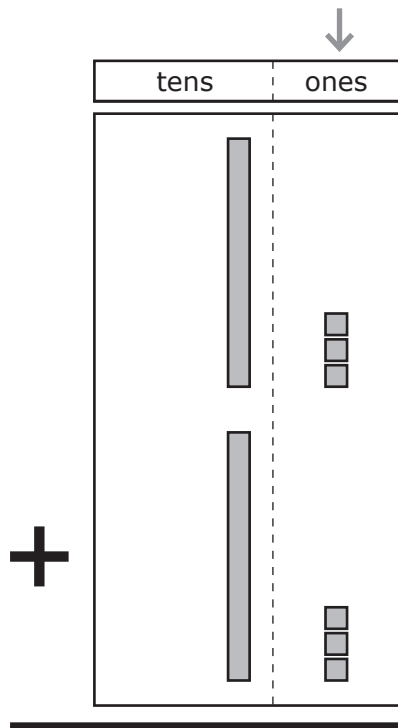
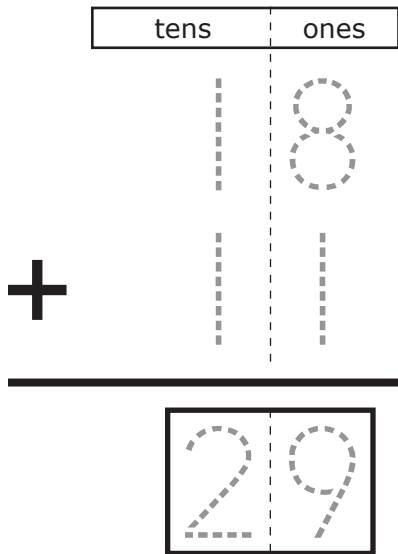
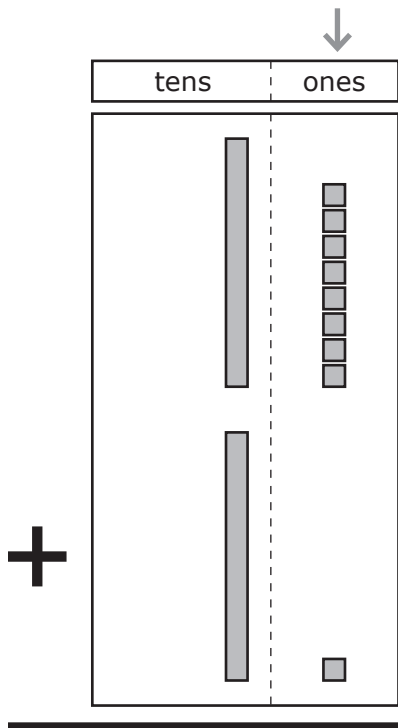

$24 + 3 = \square$ $13 + 14 = \square$

Name _____

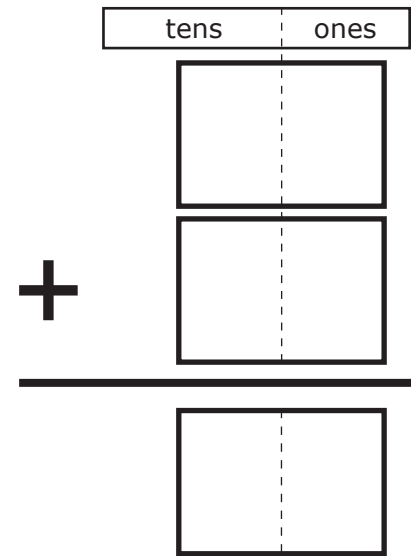
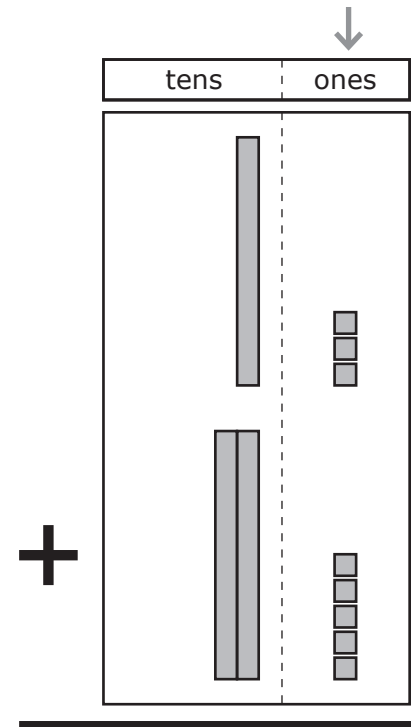
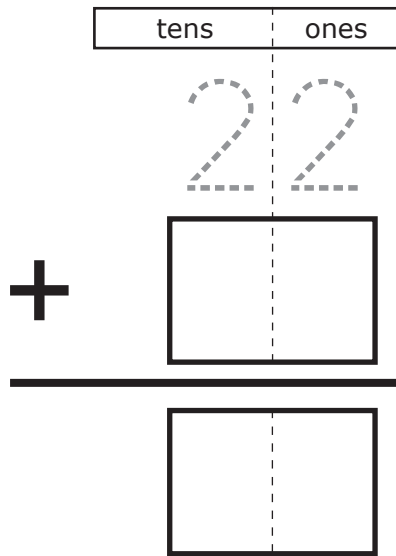
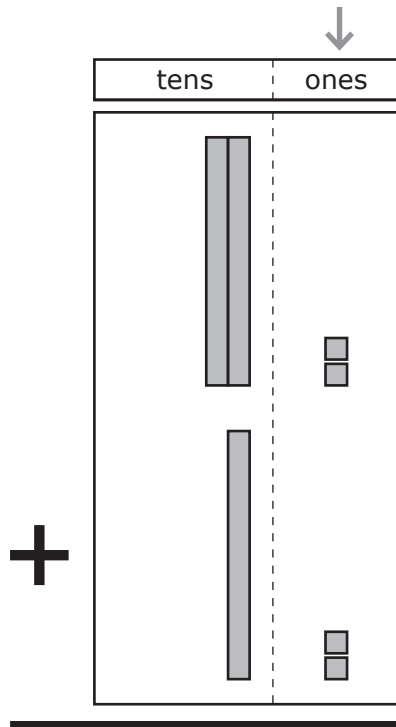
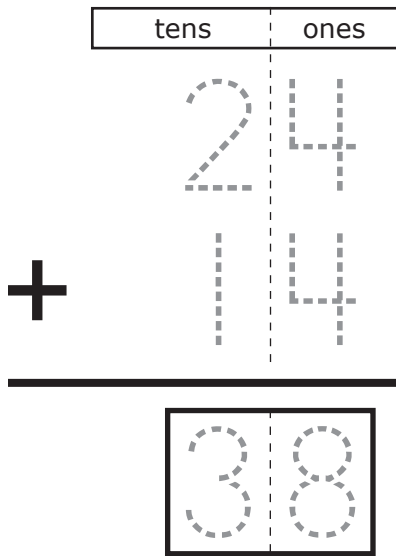
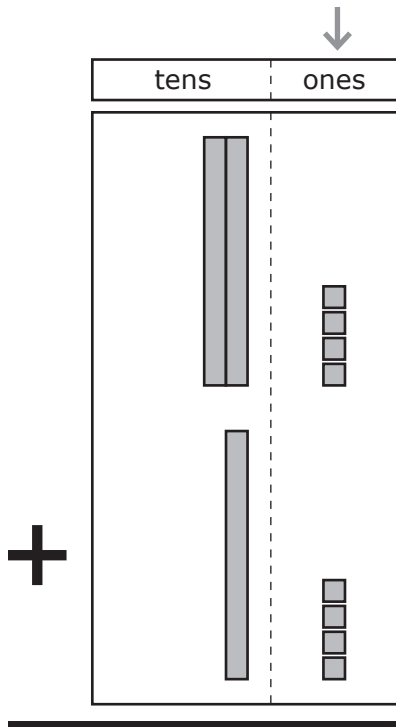

We have p.e. for 20🕒 (minutes). We have art for 15 minutes. How much time do we have for p.e. and art?

+ = minutes

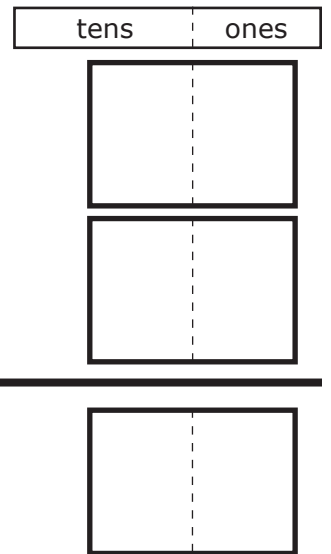
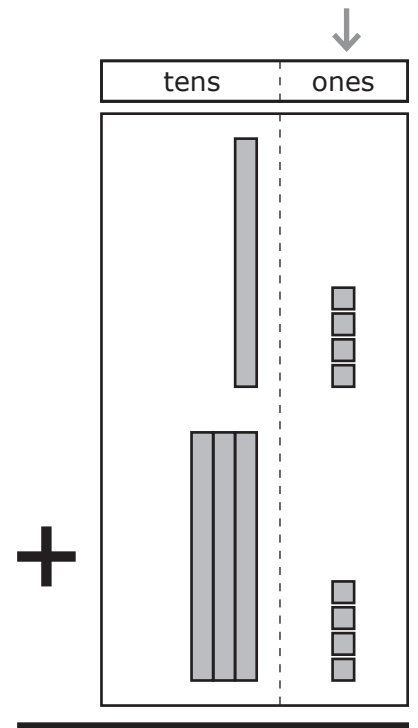
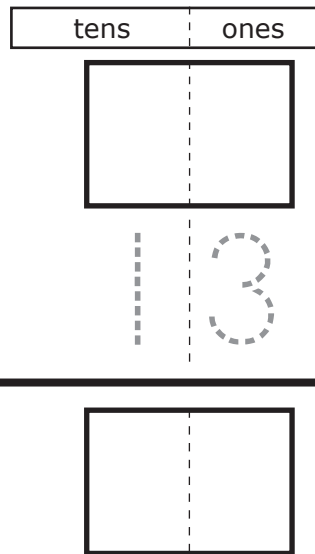
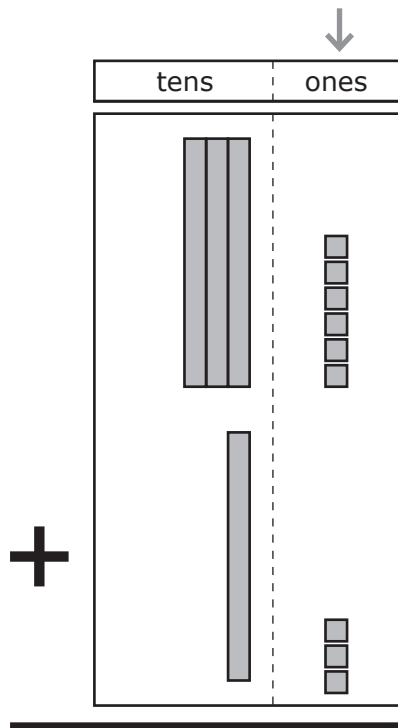
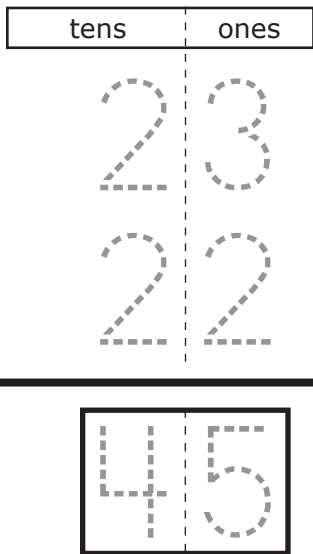
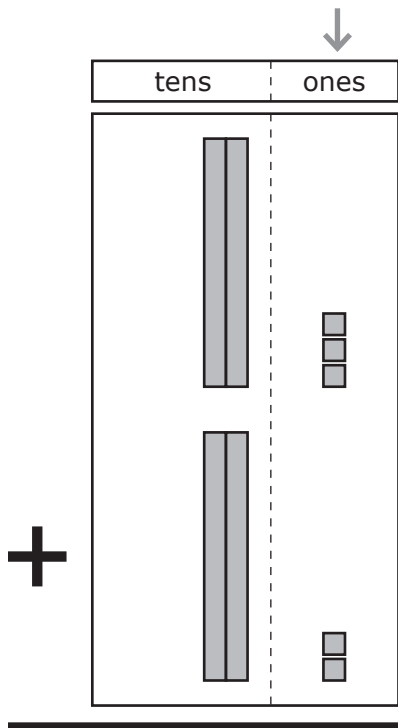

Name _____

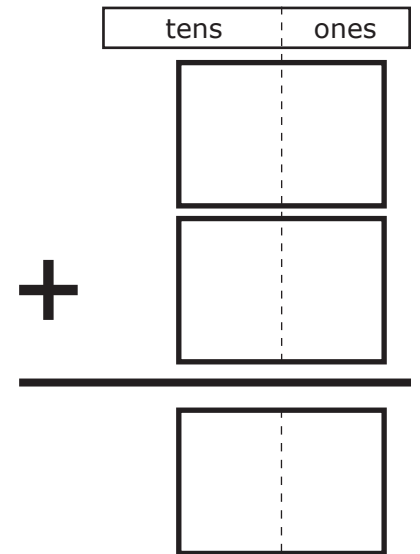
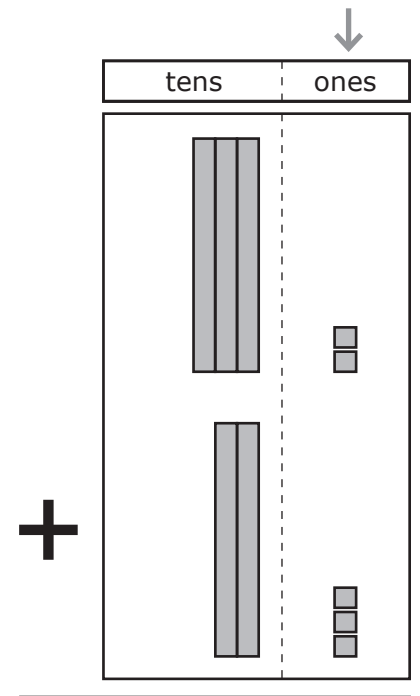
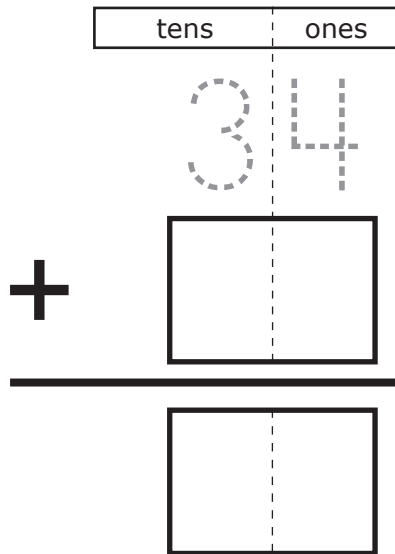
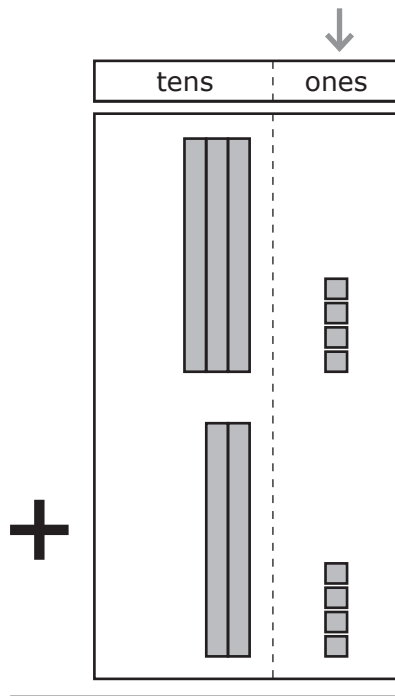
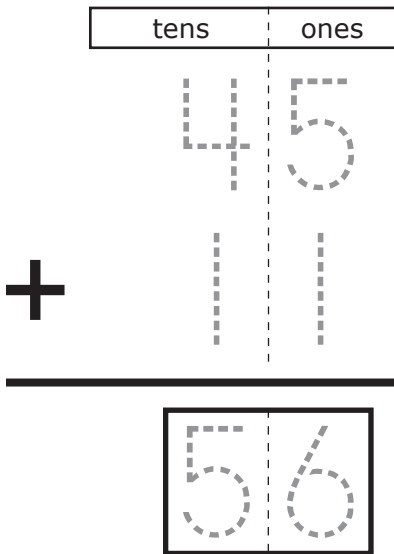
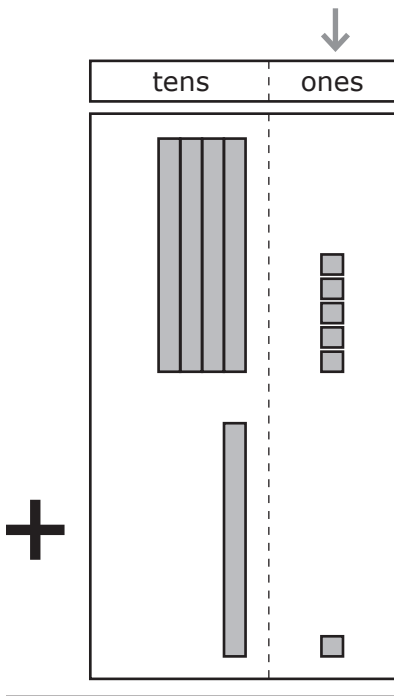

31 + 17 □ 28 + 11

Name _____



We go to  (art) for 25 minutes. We go to  (music) for 30 minutes. How much time do we have for art and music?

+ = minutes

Name _____

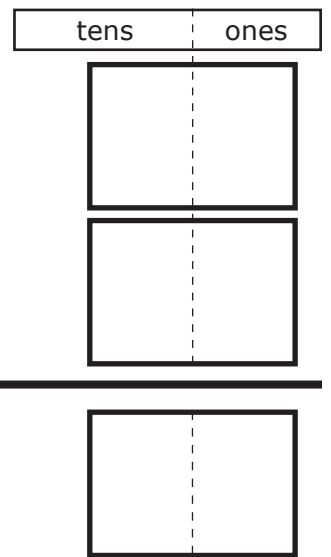
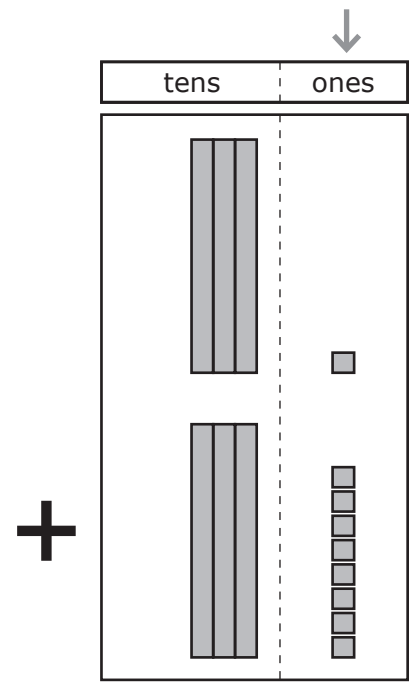
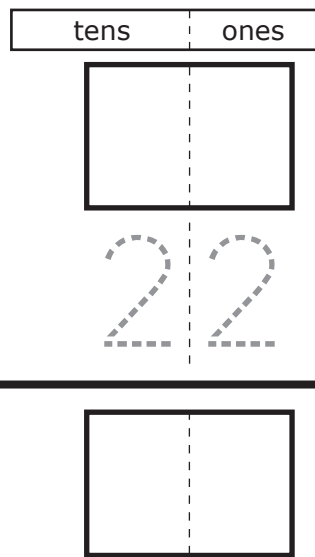
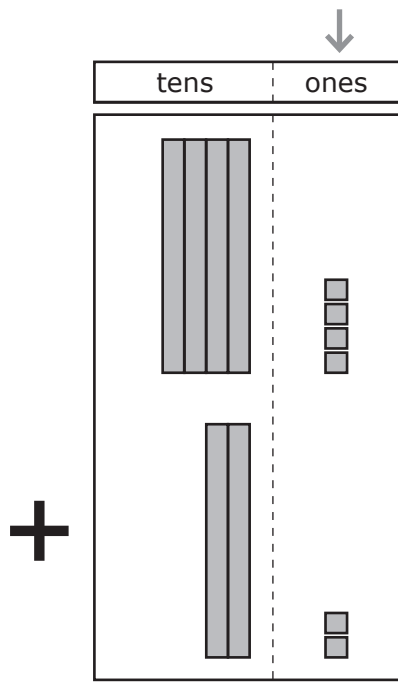
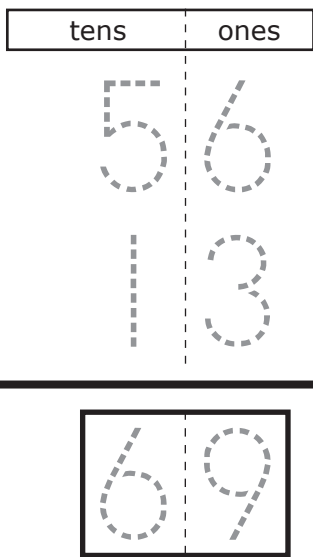
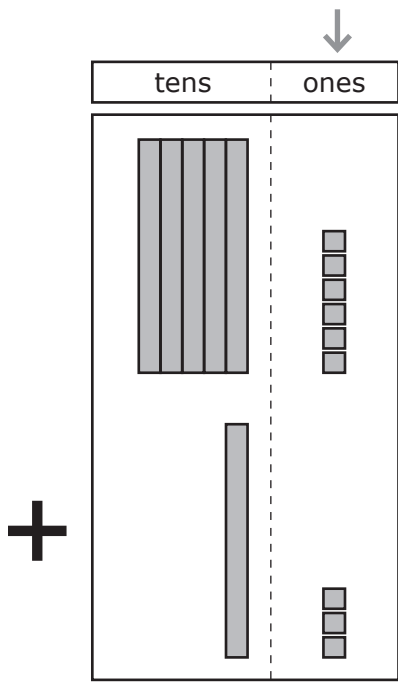

$45 + 21 \square 35 + 33$

Name _____

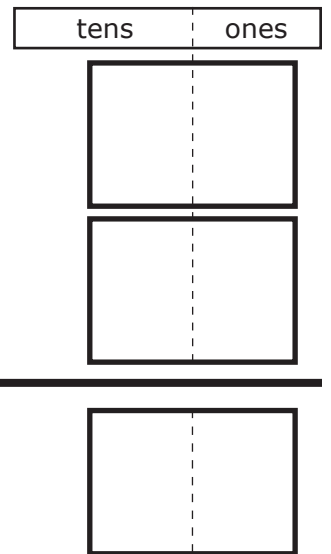
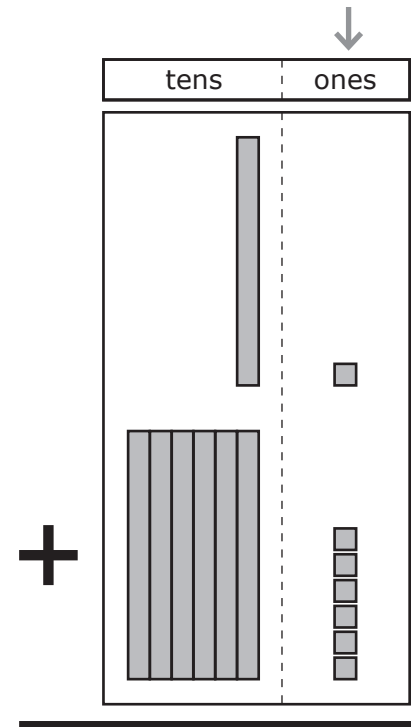
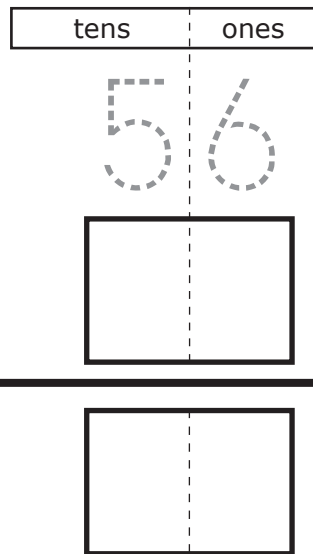
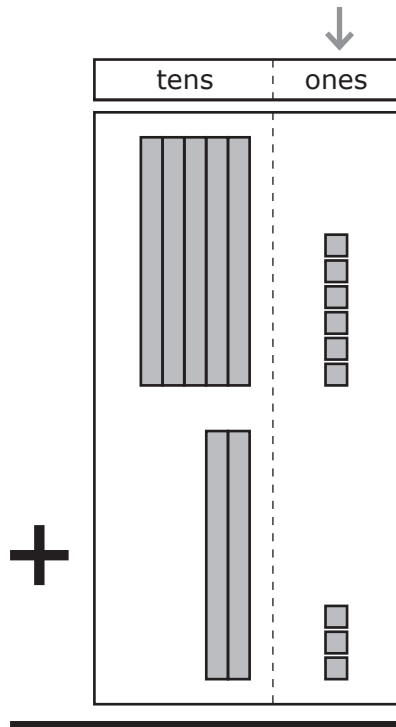
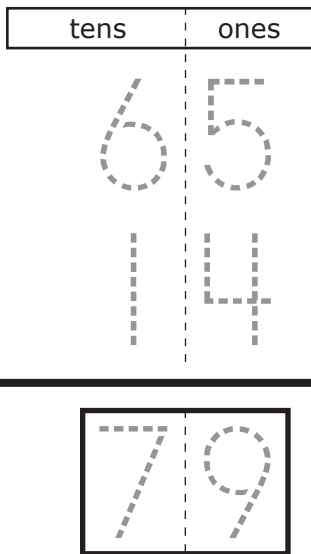
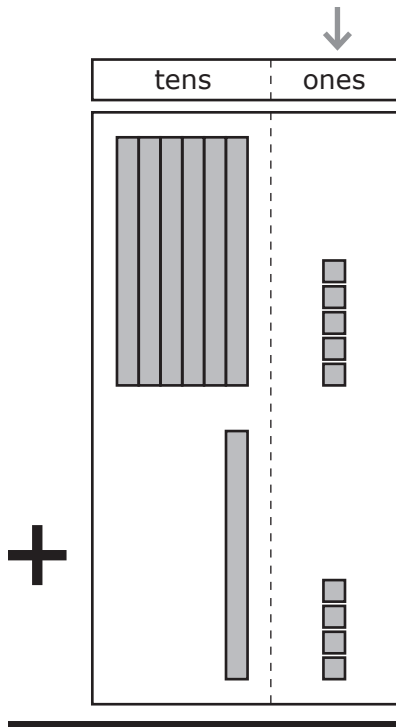

We have  (library) for 25 minutes. We then have 50 minutes to read. How much time do we have to be in the library and read?

+ = minutes

Name _____

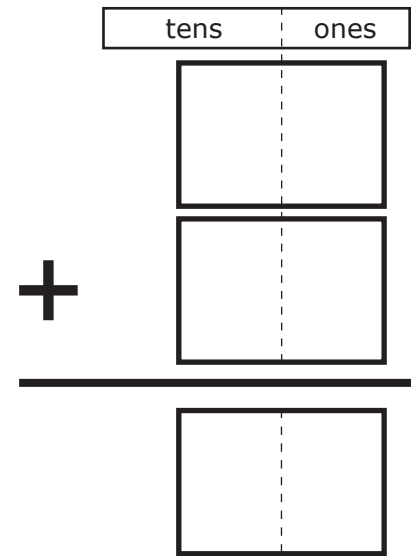
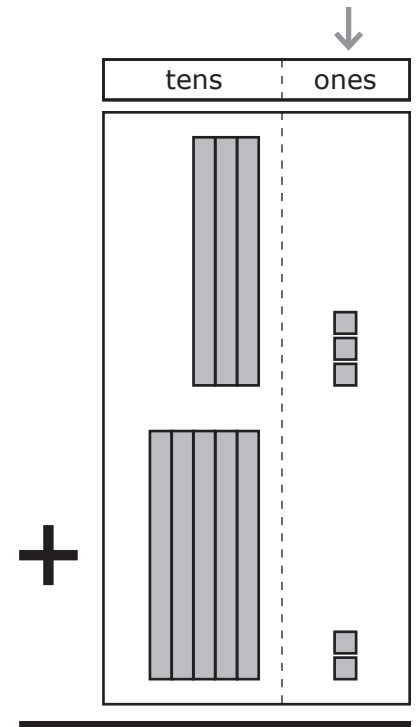
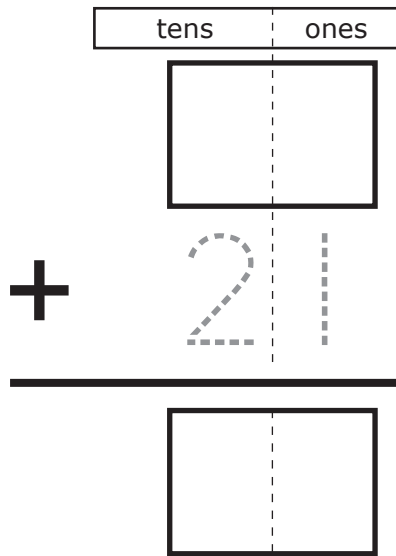
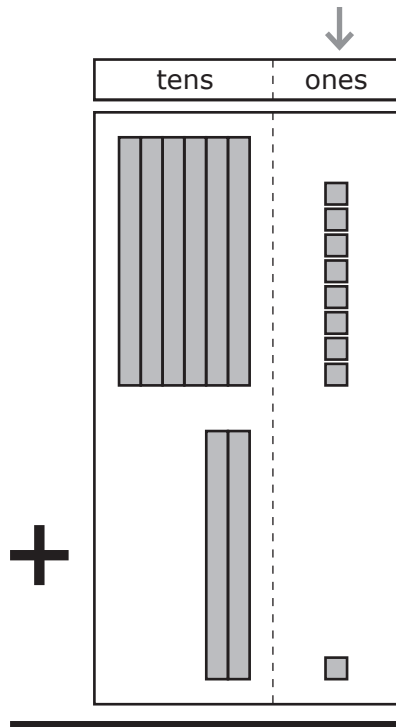
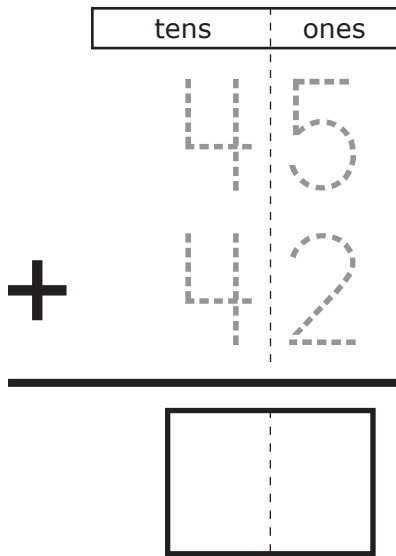
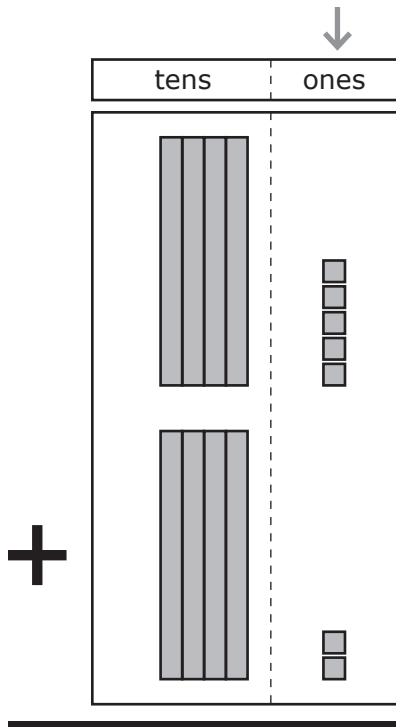

I  (jump rope) 36 times on one day. I jump rope 42 times on another day. How many times do I jump rope on the two days?

$$\boxed{} + \boxed{} = \boxed{} \text{ times}$$

Name _____

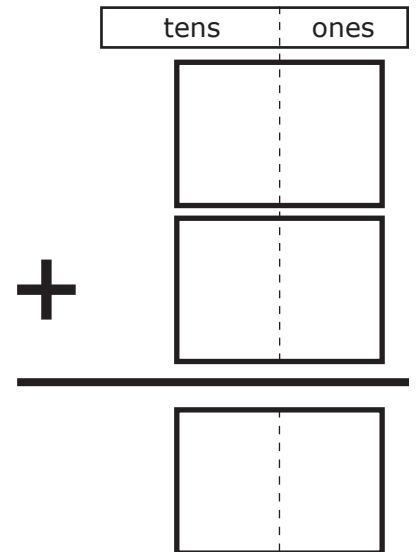
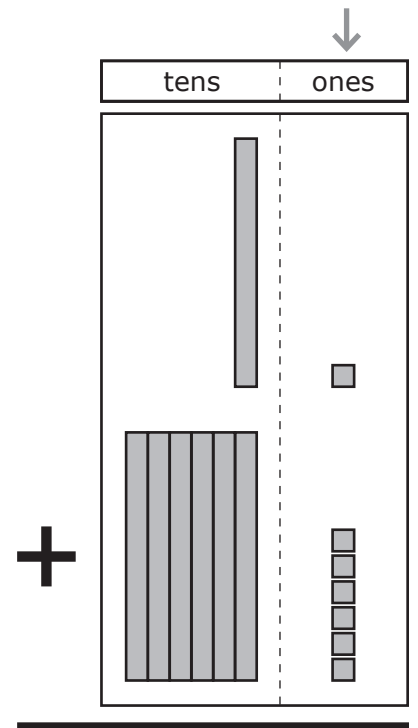
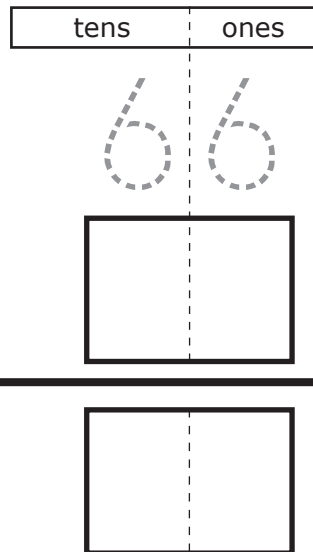
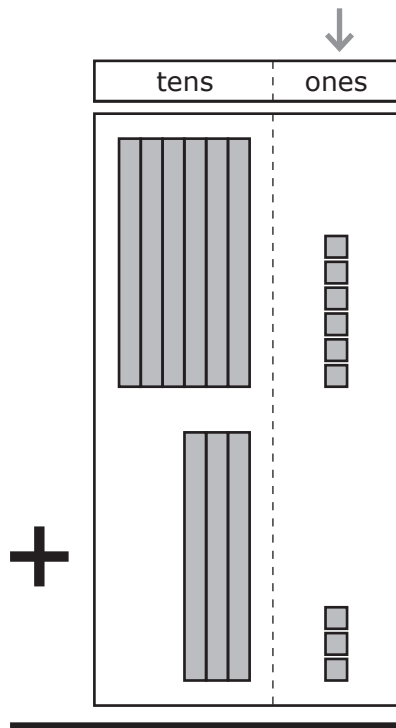
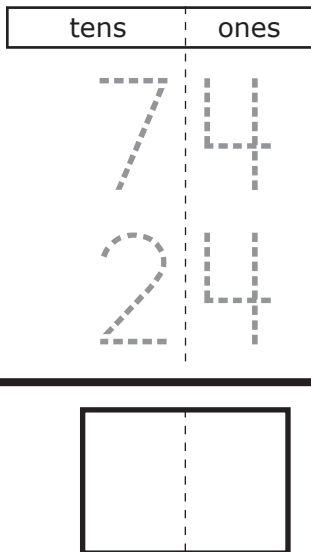
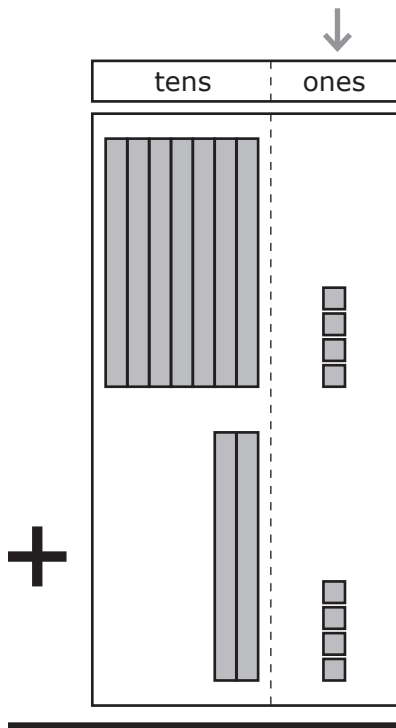

83 + 14 □ 38 + 41

Name _____

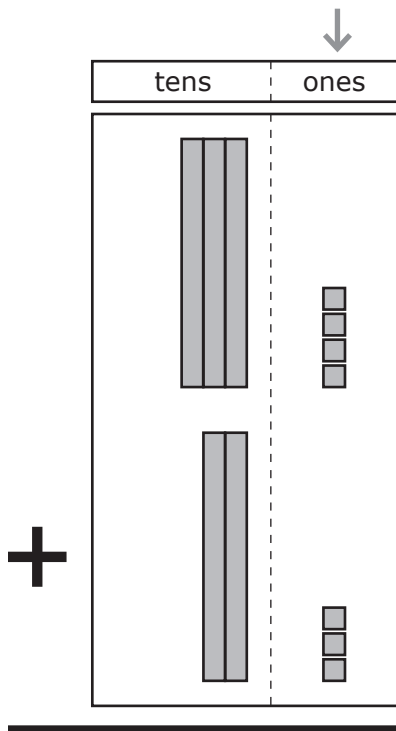

75

- True
 False

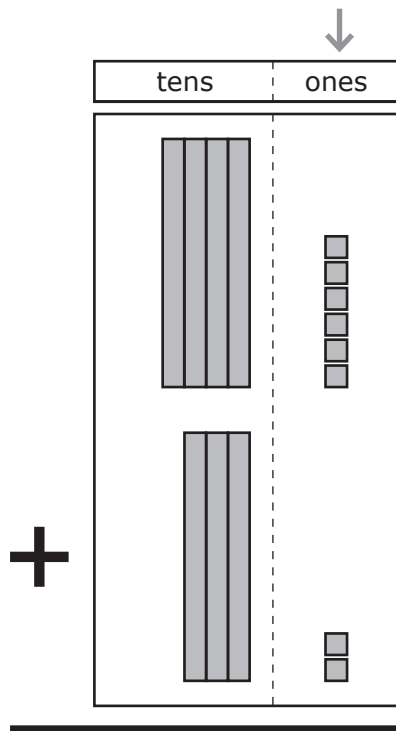

87

- True
 False

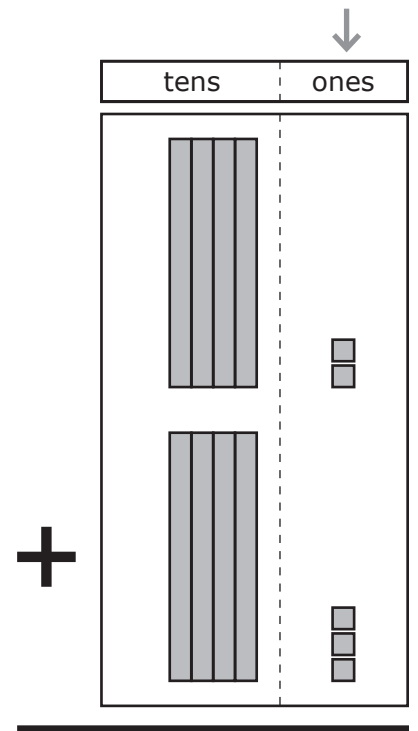

85

- True
 False

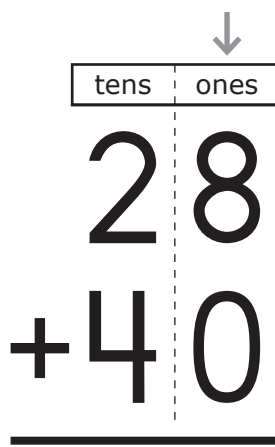

=

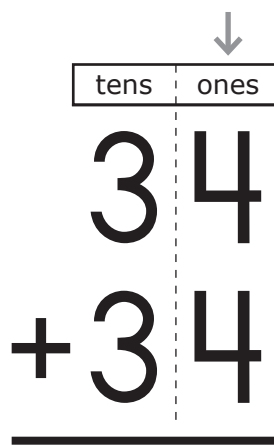

- True
 False

Name _____

Lyn made 15 blue hats. She also made 41 red hats.
How many hats did Lyn make **in all**?

$$\begin{array}{|c|c|} \hline & \\ \hline \end{array} + \begin{array}{|c|c|} \hline & \\ \hline \end{array} = \begin{array}{|c|c|} \hline & \\ \hline \end{array} \text{ hats}$$

↓

tens	ones
------	------

$$\begin{array}{|c|c|} \hline 3 & 3 \\ \hline + & 5 & 1 \\ \hline \end{array}$$

↓

tens	ones
------	------

$$\begin{array}{|c|c|} \hline 3 & 5 \\ \hline + & 3 & 3 \\ \hline \end{array}$$

↓

tens	ones
------	------

$$\begin{array}{|c|c|} \hline 6 & 3 \\ \hline + & 1 & 1 \\ \hline \end{array}$$

↓

tens	ones
------	------

$$\begin{array}{|c|c|} \hline 4 & 2 \\ \hline + & 1 & 5 \\ \hline \end{array}$$

↓

tens	ones
------	------

$$\begin{array}{|c|c|} \hline 7 & 4 \\ \hline + & 1 & 5 \\ \hline \end{array}$$

↓

tens	ones
------	------

$$\begin{array}{|c|c|} \hline 3 & 6 \\ \hline + & 2 & 2 \\ \hline \end{array}$$

Name _____

↓

tens	ones
------	------

$$\begin{array}{r} 22 \\ + 21 \\ \hline \square \square \end{array}$$

↓

tens	ones
------	------

$$\begin{array}{r} 15 \\ + 31 \\ \hline \square \square \end{array}$$

↓

tens	ones
------	------

$$\begin{array}{r} 24 \\ + 11 \\ \hline \square \square \end{array}$$

$44 + 44 \square 33 + 33$

↓

tens	ones
------	------

$$\begin{array}{r} 82 \\ + 11 \\ \hline \square \square \end{array}$$

↓

tens	ones
------	------

$$\begin{array}{r} 60 \\ + 18 \\ \hline \square \square \end{array}$$

↓

tens	ones
------	------

$$\begin{array}{r} 34 \\ + 13 \\ \hline \square \square \end{array}$$

Name _____

↓

tens	ones
------	------

$$\begin{array}{r} 70 \\ + 13 \\ \hline \end{array}$$

--	--

↓

tens	ones
------	------

$$\begin{array}{r} 11 \\ + 53 \\ \hline \end{array}$$

--	--

↓

tens	ones
------	------

$$\begin{array}{r} 45 \\ + 11 \\ \hline \end{array}$$

--	--

↓

tens	ones
------	------

$$\begin{array}{r} 32 \\ + 25 \\ \hline \end{array}$$

--	--

↓

tens	ones
------	------

$$\begin{array}{r} 23 \\ + 42 \\ \hline \end{array}$$

--	--

↓

tens	ones
------	------

$$\begin{array}{r} 28 \\ + 11 \\ \hline \end{array}$$

--	--

Chang has 24 toy  (horses). If Chang gets 13 more horses, how many toy horses will he have **altogether**?

$$\begin{array}{|c|} \hline \\ \hline \end{array} + \begin{array}{|c|} \hline \\ \hline \end{array} = \begin{array}{|c|} \hline \\ \hline \end{array} \text{ horses}$$

Name _____

$$57 + 21 \quad \square \quad 71 + 12$$

↓

tens	ones
2	2
+	
3	1

↓

tens	ones
8	4
+	
1	5

↓

tens	ones
8	0
+	
1	5

↓

tens	ones
6	4
+	
1	2

↓

tens	ones
4	2
+	
2	2

↓

tens	ones
6	7
+	
1	1

Name _____

↓

tens	ones
------	------

$$\begin{array}{r} 87 \\ + 11 \\ \hline \end{array}$$

↓

tens	ones
------	------

$$\begin{array}{r} 70 \\ + 17 \\ \hline \end{array}$$

↓

tens	ones
------	------

$$\begin{array}{r} 17 \\ + 21 \\ \hline \end{array}$$

Zita goes on 15  (circus) rides. Nita goes on 33 circus rides. What is the **total** number of rides the girls go on?

$$\begin{array}{|c|c|} \hline & \\ \hline \end{array} + \begin{array}{|c|c|} \hline & \\ \hline \end{array} = \begin{array}{|c|c|} \hline & \\ \hline \end{array} \text{ rides}$$

↓

tens	ones
------	------

$$\begin{array}{r} 51 \\ + 24 \\ \hline \end{array}$$

↓

tens	ones
------	------

$$\begin{array}{r} 28 \\ + 41 \\ \hline \end{array}$$

↓

tens	ones
------	------

$$\begin{array}{r} 45 \\ + 13 \\ \hline \end{array}$$

Name _____

$$\begin{array}{r} \downarrow \\ 74 \\ + 23 \\ \hline \end{array}$$

$$\boxed{76}$$

$$\begin{array}{r} \downarrow \\ 44 \\ + 44 \\ \hline \end{array}$$

$$\begin{array}{r} \downarrow \\ 43 \\ + 33 \\ \hline \end{array}$$

$$\boxed{97}$$

$$\begin{array}{r} \downarrow \\ 51 \\ + 25 \\ \hline \end{array}$$

$$\begin{array}{r} \downarrow \\ 57 \\ + 12 \\ \hline \end{array}$$

$$\boxed{88}$$

$$\begin{array}{r} \downarrow \\ 66 \\ + 31 \\ \hline \end{array}$$

$$\begin{array}{r} \downarrow \\ 65 \\ + 23 \\ \hline \end{array}$$

$$\boxed{69}$$

$$\begin{array}{r} \downarrow \\ 44 \\ + 25 \\ \hline \end{array}$$

Name _____

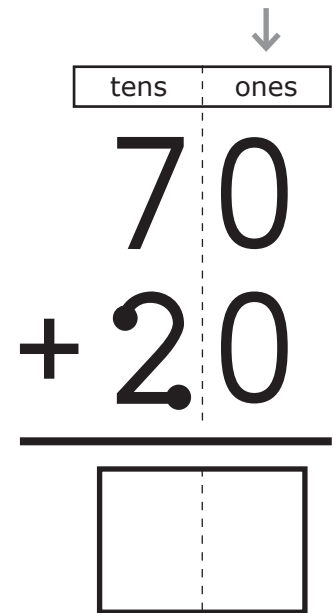
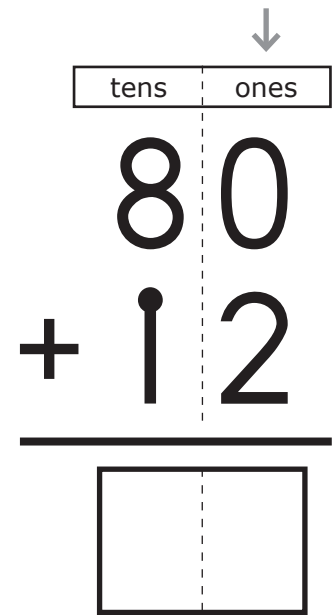
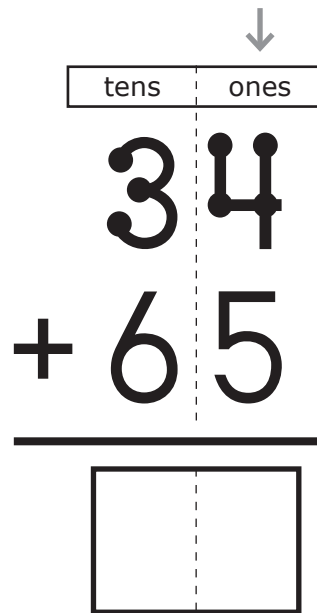
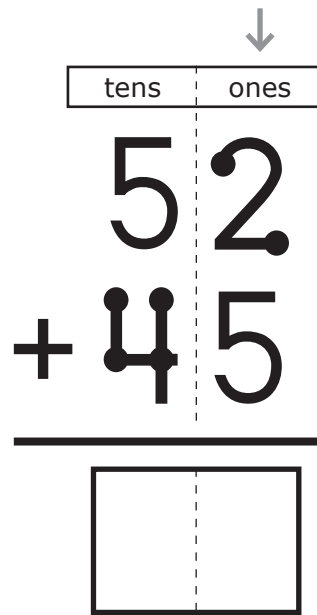
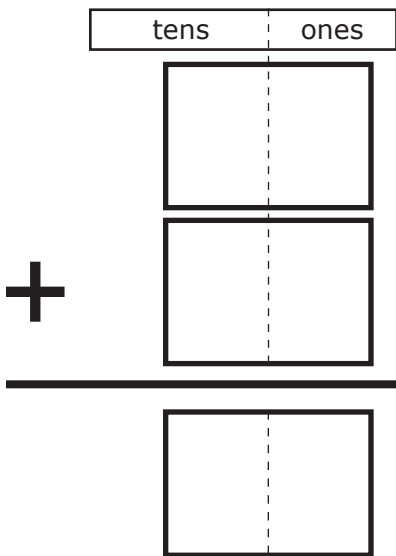
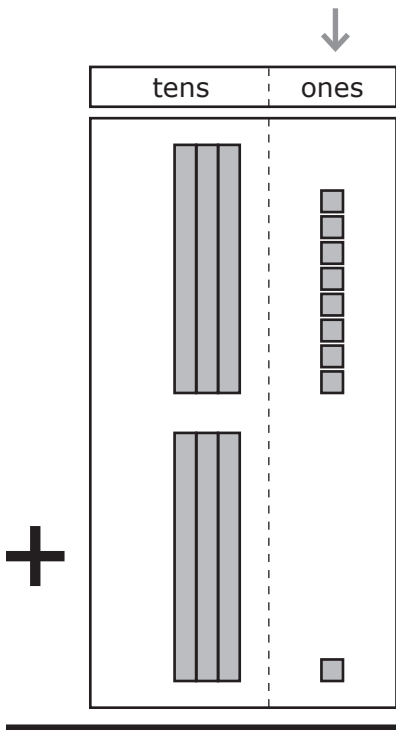

Tom and Sam each read 42 pages in a book.
How many pages in **total** did Tom and Sam read?

	+		=		pages
---	---	---	---	---	-------