

Draw a picture of a set of 10 objects.

Name _____ Date _____

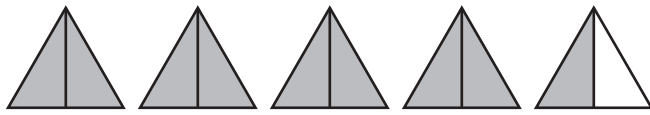

=

Mixed number
 $4\frac{1}{2}$

=

Improper fraction
 $\frac{9}{2}$

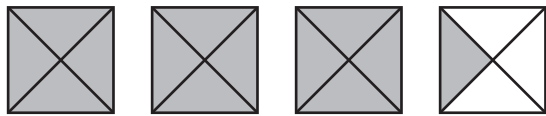

=

=

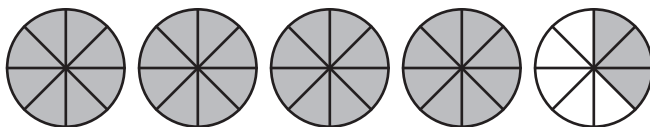

=

=

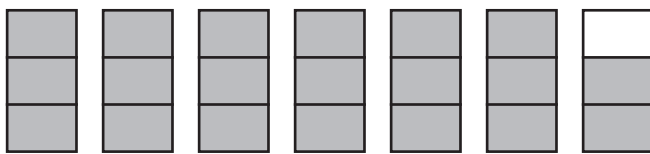

=

=

$2\frac{1}{4} = \frac{\quad}{4}$

$3\frac{4}{5} = \frac{\quad}{5}$

$6\frac{1}{6} = \frac{\quad}{6}$

$4\frac{3}{8} = \frac{\quad}{8}$

$4\frac{2}{4} = \frac{\quad}{4}$

$5\frac{3}{5} = \frac{\quad}{5}$

$2\frac{5}{8} = \frac{\quad}{8}$

$10\frac{3}{9} = \frac{\quad}{9}$

$9\frac{2}{6} = \frac{\quad}{6}$

$8\frac{3}{4} = \frac{\quad}{4}$

$3\frac{1}{3} = \frac{\quad}{3}$

$5\frac{1}{4} = \frac{\quad}{4}$

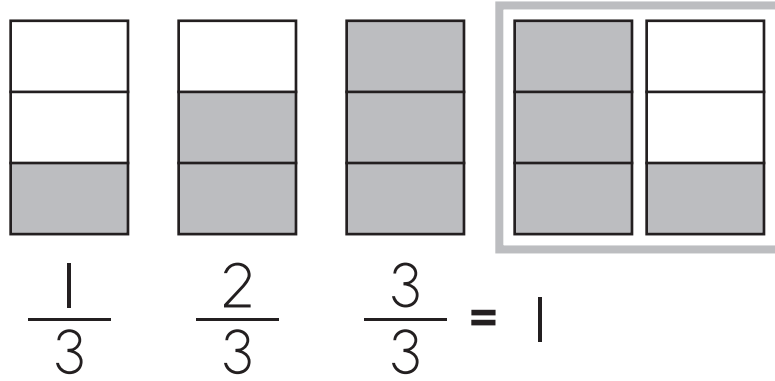

$\frac{4}{3} =$ improper fraction $=$

$1\frac{1}{3} =$ mixed number

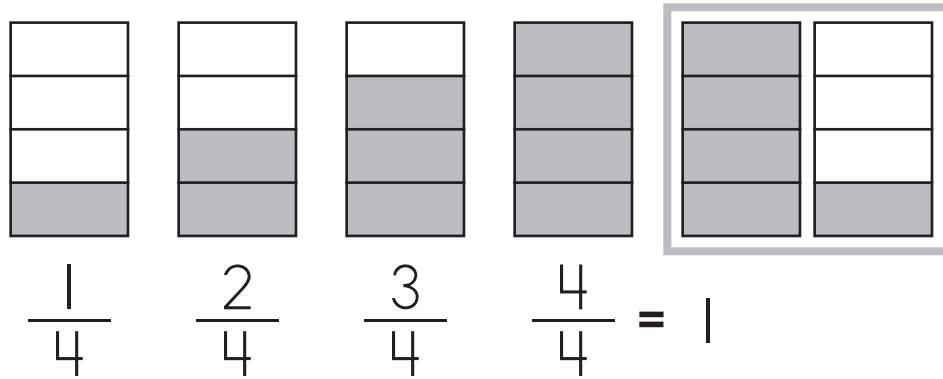

$\frac{5}{4} =$ improper fraction $=$

$1\frac{1}{4} =$ mixed number

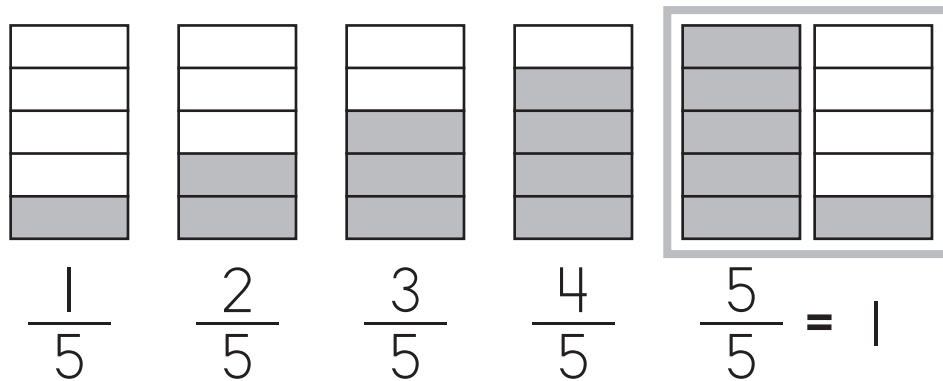

$\frac{6}{5} =$ improper fraction $=$

$1\frac{1}{5} =$ mixed number

1. $\frac{5}{3}$ $\frac{6}{3}$ $\frac{7}{3}$ $\frac{8}{3}$

2. $\frac{6}{4}$ $\frac{7}{4}$ $\frac{8}{4}$ $\frac{9}{4}$

3. $\frac{1}{6}$ $\frac{2}{6}$ $\frac{3}{6}$ $\frac{4}{6}$

4. $\frac{7}{5}$ $\frac{8}{5}$ $\frac{9}{5}$ $\frac{10}{5}$

As the denominator increases, the fractional part decreases.

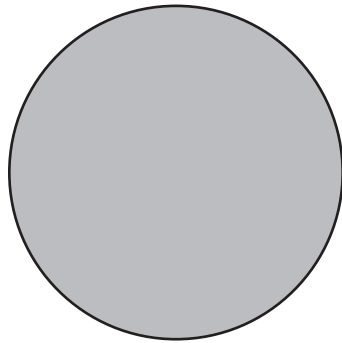

—

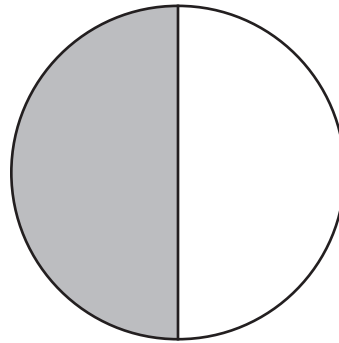

—

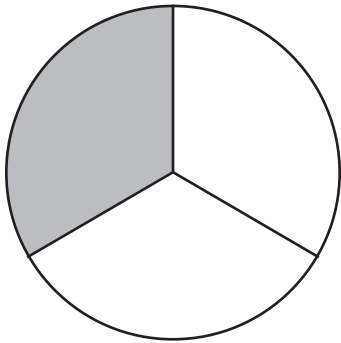

—

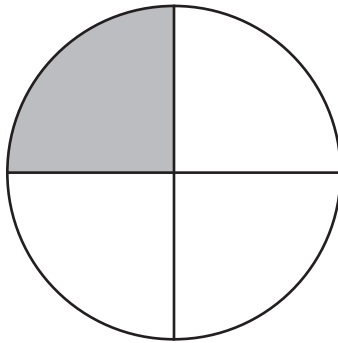

—

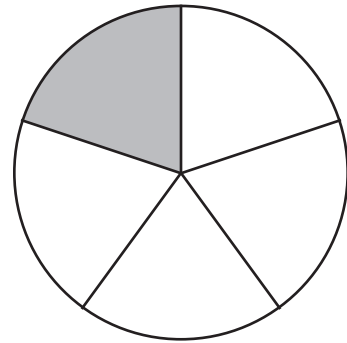

—

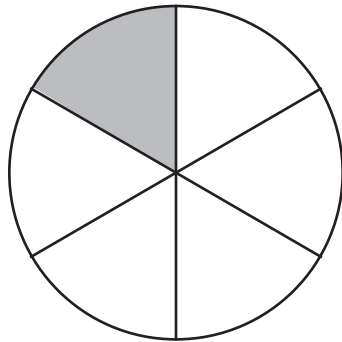

—

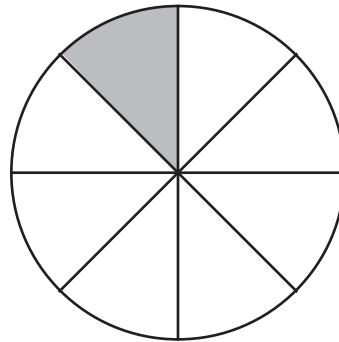

—

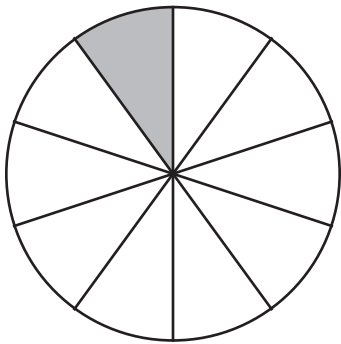

—

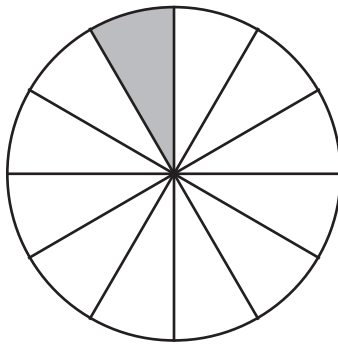

—

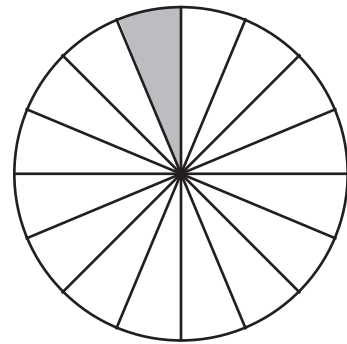

—

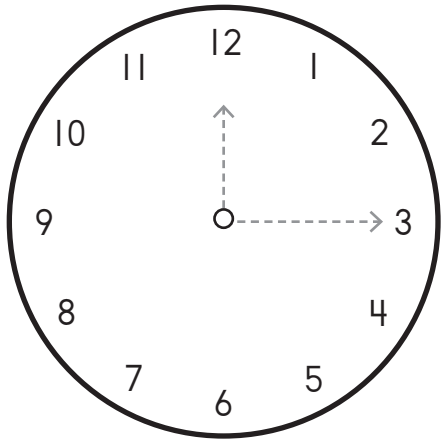

$\frac{3}{12}$

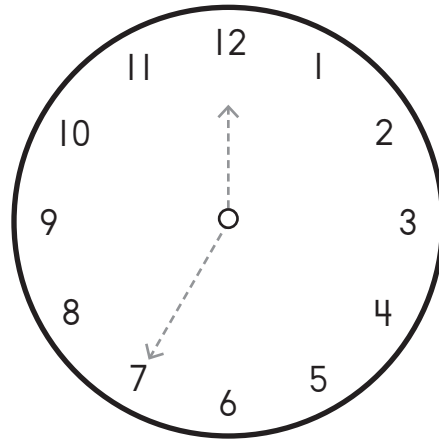

three-twelfths

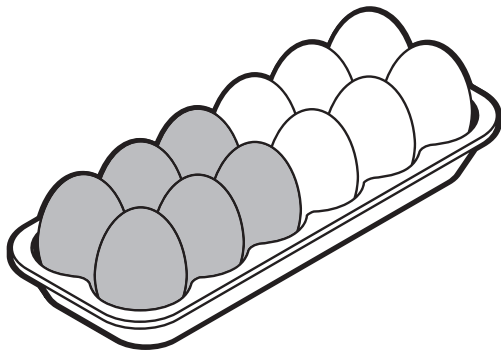

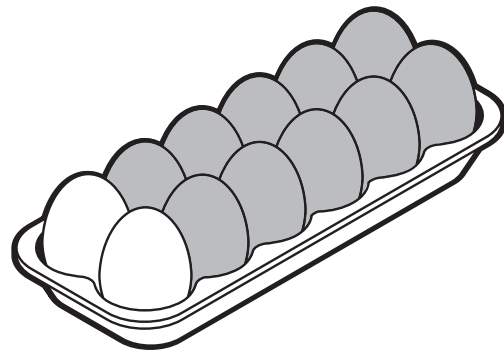

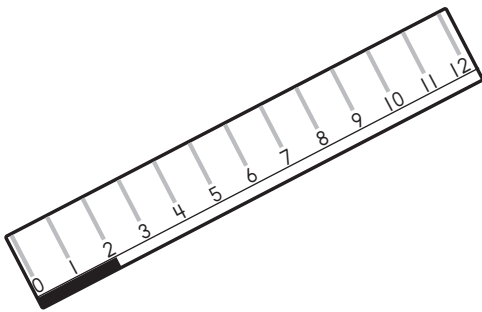

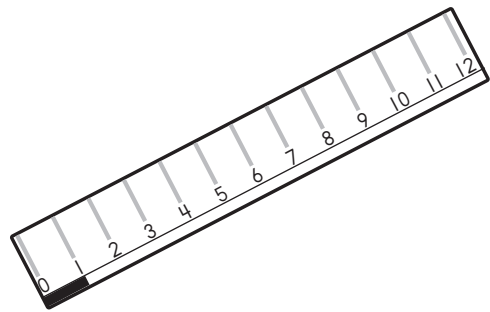

1.

A fraction is a whole that is divided into _____ parts.

- (A) equal
- (B) one or two
- (C) zero

2.

The number of fractional parts in a whole is the _____.

- (A) numerator
- (B) denominator
- (C) sum

3.

An improper fraction has a _____.

- (A) numerator < denominator
- (B) numerator of 0
- (C) numerator > denominator

4.

Five-sixteenths

- (A) $\frac{6}{16}$
- (B) $\frac{5}{6}$
- (C) $\frac{5}{16}$

5.



- (A) $\frac{4}{5}$
- (B) $\frac{3}{4}$
- (C) $\frac{1}{3}$

6.



- (A) $\frac{3}{5}$
- (B) $\frac{3}{10}$
- (C) $\frac{4}{8}$

7.



- (A) three-thirds
- (B) three-fourths
- (C) three-fifths

8.



- (A) seven-eighths
- (B) nine-tenths
- (C) eleven-twelfths

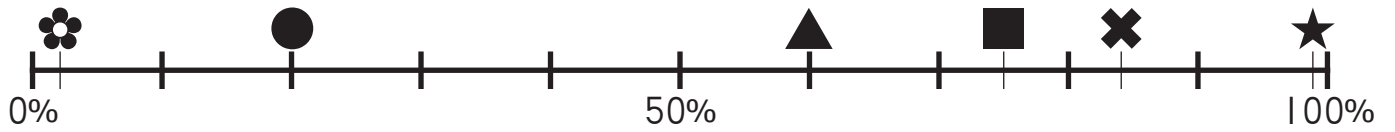

1.

60% (A) ●
 (B) ■
 (C) ▲

2.

99% (A) ●
 (B) ★
 (C) ●

3.

20% (A) ●
 (B) X
 (C) ▲

4.

2% (A) X
 (B) ★
 (C) ●

5.

84% (A) X
 (B) ●
 (C) ●

6.

75% (A) ★
 (B) ▲
 (C) ■



7.

275% (A) ●
 (B) ♥
 (C) ◆

8.

449% (A) ♣
 (B) ◆
 (C) ▼

9.

150% (A) ●
 (B) ◆
 (C) ♥

10.

395% (A) ♣
 (B) ◆
 (C) ▼

11.

492% (A) ♥
 (B) ◆
 (C) ▼

12.

210% (A) ♥
 (B) ●
 (C) ◆

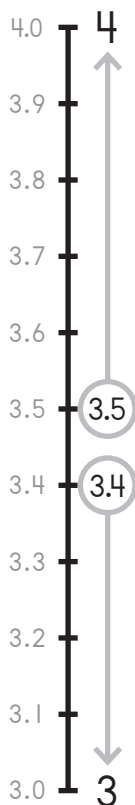
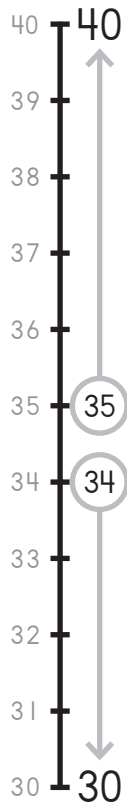

1.

3.3 rounds to 3.

2.

4.7 rounds to 5.

3.

2.5 rounds to 3.

4.

7.4 rounds to _____.

5.

5.1 rounds to _____.

6.

6.9 rounds to _____.

7.

9.8 rounds to _____.

8.

8.2 rounds to _____.